

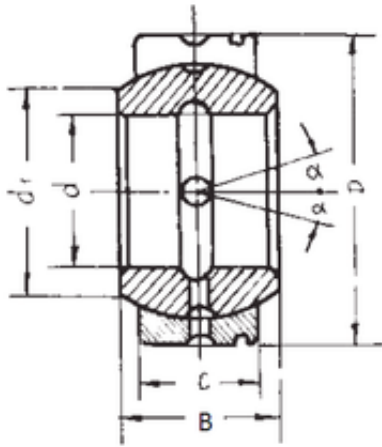

NTNY BEARING LTD

60 mm x 100 mm x 53 mm FBJ GE60XS/K plain bearings



Bearing No. GE60XS/K

Size	60x100x53 mm
Bore Diameter	60 mm
Outer Diameter	100 mm
Width	53 mm
d	60 mm
D	100 mm
B	53 mm
C	45 mm
d1	72,5 mm
Angle	6 °
Weight	1,72 Kg
Basic dynamic load rating (C)	321 kN

GE60XS/K Bearing 2D drawings and 3D CAD models