

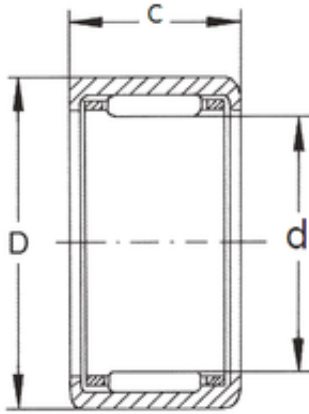

NTNY BEARING LTD

FBJ HK1015 needle roller bearings



Bearing No. HK1015

Size	10x14x15 mm
Bore Diameter	10 mm
Outer Diameter	14 mm
Width	15 mm
d	10 mm
D	14 mm
C	15 mm
Weight	0,006 Kg
Basic dynamic load rating (C)	6,7 kN
Basic static load rating (C0)	7,8 kN
(Grease) Lubrication Speed	11500 r/min

HK1015 Bearing 2D drawings and 3D CAD models