

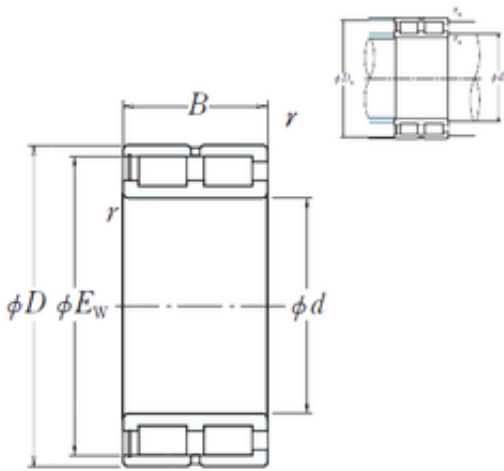

NNCF5032V NSK CYLINDRICAL ROLLER BEARING

Bearing No. NNCF5032V



NNCF5032V Bearing 2D drawings and 3D CAD models

Size	160x224.8x109 mm
Bore Diameter	160 mm
Outer Diameter	224,8 mm
Width	109 mm
d	160 mm
D	240 mm
Ew	224,8 mm
B	109 mm
C	109 mm
r min.	2,1 mm
Da	225 mm
ra max.	2 mm
da	175 mm
Weight	15,8 Kg
Basic dynamic load rating (C)	895 kN