

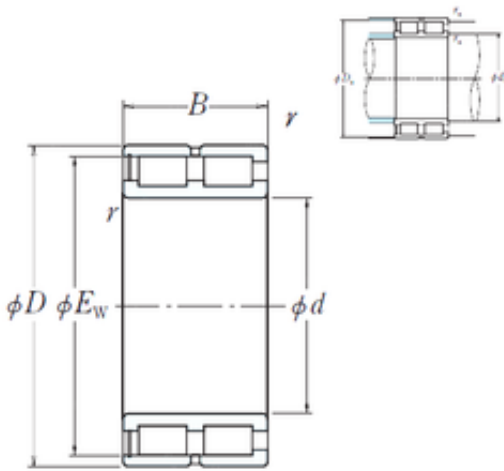

NNCF5048V NSK CYLINDRICAL ROLLER BEARING

Bearing No. NNCF5048V



NNCF5048V Bearing 2D drawings and 3D CAD models

Size	240x335.25x160 mm
Bore Diameter	240 mm
Outer Diameter	335,25 mm
Width	160 mm
d	240 mm
D	360 mm
Ew	335,25 mm
B	160 mm
C	160 mm
r min.	3 mm
Da	340 mm
ra max.	2,5 mm
da	259 mm
Weight	54,3 Kg
Basic dynamic load rating (C)	1990 kN