

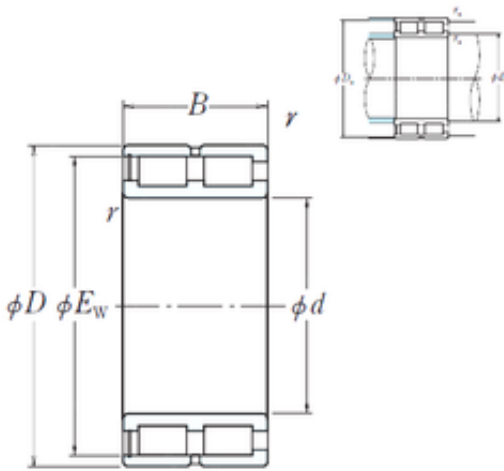

NNCF4964V NSK CYLINDRICAL ROLLER BEARING

Bearing No. NNCF4964V



NNCF4964V Bearing 2D drawings and 3D CAD models

Size	320x404.5x118 mm
Bore Diameter	320 mm
Outer Diameter	404,5 mm
Width	118 mm
d	320 mm
D	440 mm
Ew	404,5 mm
B	118 mm
C	118 mm
r min.	3 mm
Da	418 mm
ra max.	2,5 mm
da	340 mm
Weight	55 Kg
Basic dynamic load rating (C)	1620 kN